







Chime Tone Intercom

DOOR 1 ROOM 1 IE-1AD(U)

<p>Door station</p>  <p>IF-DA Door station → P.31</p>	<p>Master station</p>  <p>IE-1AD(U) Master station</p>	<p>Lineup</p> <div style="display: flex; justify-content: space-around;"> <div style="text-align: center;">  <p>EL-12S Electric door strike → P.103</p> </div> <div style="text-align: center;">  <p>AC-10S Access control keypad, surface mount → P.101</p> </div> </div> <div style="display: flex; justify-content: space-around; margin-top: 20px;"> <div style="text-align: center;">  <p>IER-2 Call extension → P.103</p> </div> <div style="text-align: center;">  <p>AC-10F Access control keypad, flush mount → P.101</p> </div> </div> <div style="text-align: center; margin-top: 20px;">  <p>TAR-3 External signaling relay → P.32</p> </div>
<p>Power supply 12~24V DC power supply 12~16V AC transformer</p>		

Features

- Chime tone intercom for 2 locations
- Door release button
- AC or DC power source

Communication network

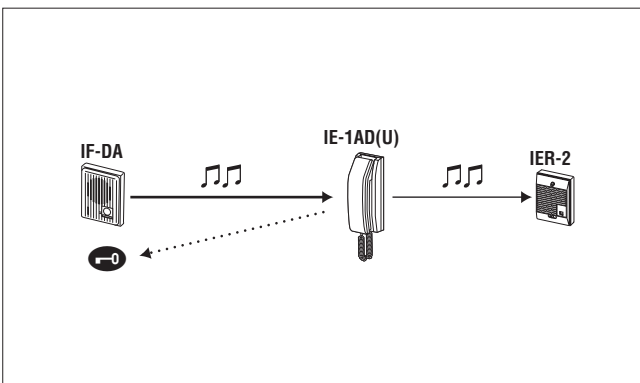

Unit dimensions

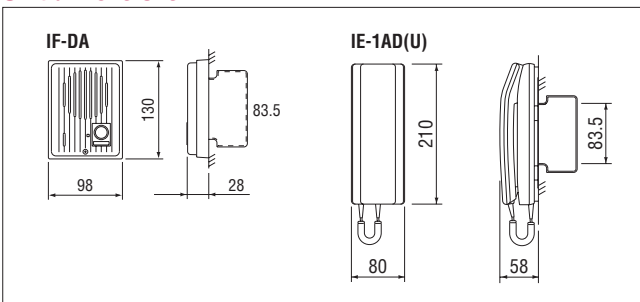

Wiring

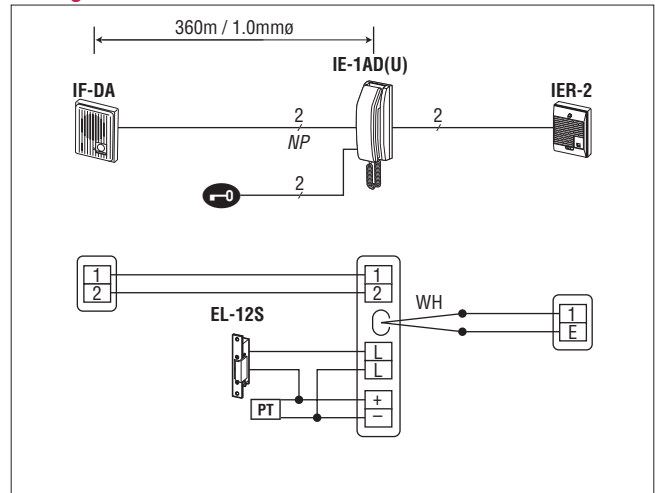

- Run audio wires in a separate jacketed cable from door release wires.
- PT** : AC transformer **WH** : White(2)

Specifications (IE-1AD(U))

Power source	12~16V AC, 180mA 12~24V DC, 160mA
Power supply	AC transformer (for IE & EL-12S), PS-1225/S/UL.
Communication	Door calls in w/4-tone chime, adjustable. Pick up handset to reply.
Door release	Contact rating: 24V AC/DC, 500mA
Wiring	2 parallel wires, non-polarized (+2 for EL-12S)
Wiring distance	IE-1AD(U) to door 150m(0.65mmø) 360m(1.0mmø)